

Thank you for purchasing our 2-Stage trigger for your Tikka T3!

INST-2ST-T3

Midas 2-Stage Trigger for Tikka T3



Contents of Package:

- T3 trigger assembled, top safety selector or bottom selector version
- Baggie with following contents:
 - 1ea socket head M6 x 20mm screw
- For bottom safety selector version:
 - 1ea selector button

WE HIGHLY RECOMMEND THAT THIS TRIGGER IS INSTALLED BY A QUALIFIED GUNSMITH

Installation Instructions:



Safety Warning: Before you attempt any installation, make sure your rifle is unloaded. Also, before starting remove the bolt and magazine from the rifle.

Step 1: Remove bolt from rifle, then remove barreled action from stock and remove current trigger. If using T3 with KRG stock, remove spring clip that is sandwiched between trigger and action on factory T3.

Step 2: With safety selector in rear position, install Midas trigger onto T3 using included socket head M6 x 20mm screw, torque to 55-65 in-lbs.

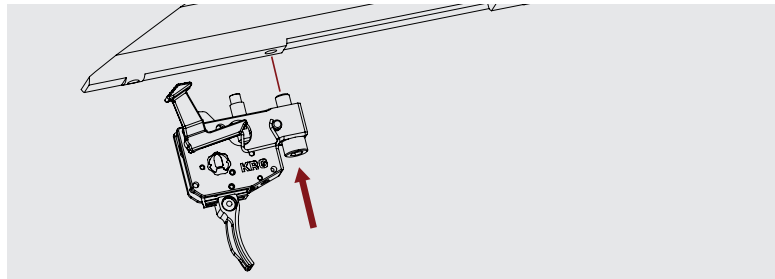

Step 3: Install barreled action back into stock.

Step 4: Check for clear chamber, then insert bolt.

Check trigger function:

- A. Move selector to rear (safe position) and pull trigger, firing pin should not move
- B. Move selector forward (fire position) and pull trigger, firing pin should fall

Step 5: (bottom safety selector version only)

Install selector button onto selector lever. It is difficult but it will snap on. Be careful not to bend the sheet metal selector lever.

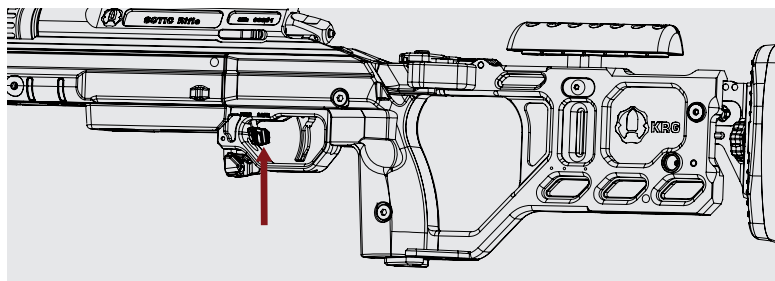

Safety Selector Positions:

Top Safety Lever

Safe is in the **REARWARD** position, away from the muzzle

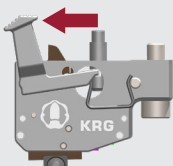

Fire is in the **FORWARD** position, toward the muzzle

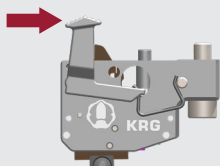

Bottom Safety Lever

Safe is in the **REARWARD** position, close to the trigger

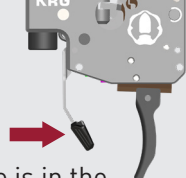

Fire is in the **FORWARD** position, away from the trigger

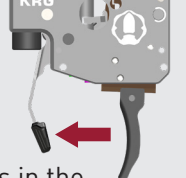

Trigger Adjustments:

*****Make sure rifle is unloaded before making any trigger adjustments*****

The trigger in the SOTIC rifle is a two-stage trigger with multiple adjustments. Some can be done by the end user and some require a certified gunsmith. Each of the end user adjustments can be done with the trigger still attached to the rifle. From left to right in the trigger graphic, here is how to make the adjustments:

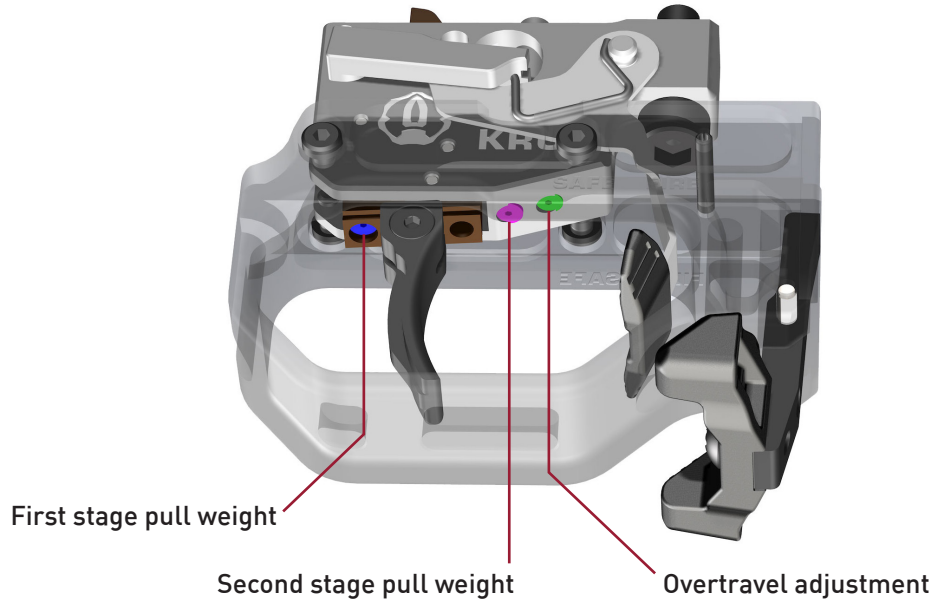

*****Do not set overall pull less than 2lb 8oz, dangerous condition could result*****

A. First stage pull weight (blue screw in image)

1. Insert 2mm hex wrench through trigger guard to turn the blue screw shown in the picture (not blue on the actual rifle). This screw might be covered by the trigger shoe. If so, loosen the flat head screw that locks the trigger shoe in place with a 2mm hex wrench and slide the trigger shoe forward.

2. Tighten the blue screw clockwise to increase the first stage pull weight. Loosen the screw to decrease first stage pull weight. If you tighten it too much, it will compress the spring to solid and the trigger will not function. If this happens, just loosen the screw. If you loosen the screw too much, the screw and spring will fall out.

B. Second stage pull weight (pink screw in image):

1. Insert 2mm hex wrench through trigger guard to turn the pink screw (not pink on the actual rifle).

2. Tighten the pink screw clockwise to increase the second stage pull weight. Loosen it to decrease second stage pull weight. If you tighten it too much, it will compress the spring to solid and the trigger will not function. If this happens, just loosen the screw. If you loosen the screw too much, the screw and spring will fall out.

C. Overtravel adjustment (green screw in image)

1. Insert bolt in rifle, make sure the rifle is not loaded.

2. Insert 2mm hex wrench through trigger guard and tighten green screw (not green on actual rifle). Pull the trigger to see if the sear drops and the firing pin activates.

3. Keep tightening the green screw until the sear does not fall and the firing pin does not activate when you pull the trigger.

4. Loosen the green screw until the sear/firing pin start working properly and then set the overtravel where you want it. This screw may need some loctite on it to stay in place.

5. If you tighten the screw too far, the trigger will not function. If this happens, just loosen the screw until the trigger functions. If you loosen the screw too much, the trigger will still function but there will be excessive overtravel which you might not prefer.

Cleaning and Maintenance:

As necessary, clean the trigger using compressed air. A mild solvent may be needed. However, avoid strong solvents as there are polymer parts in the trigger which a strong solvent could damage.

