

Congratulations on your purchase of the KRG C-4 Chassis.  
We trust that you will find it to be the premier competition chassis for your precision rifle.



INST-C4X-R75

# C-4 Chassis

## Contents of Package:

- C-4 Chassis assembled – accepts 5 or 10rd AICS and AW magazines
- Baggie with following contents:
  - 2ea 1/4"-28 x 1 3/4" Socket Head Screw (Front and Rear Action Screw)
  - 2ea M6 Thin Washer for Front and Rear Action Screws
  - .5ml tube Medium Blue Loctite
  - 1ea 3/16" Hex Bit for Action Screws
  - 1ea 3mm Hex Bit for all C-4 adjustable hardware
  - 4ea Dowel Pin for optional more permanent Barrel Shroud mounting

## Installation Instructions:



**Safety Warning:** Before you attempt any installation, make sure your rifle is unloaded. Also, before starting, remove the bolt and magazine from the rifle.

## Part I: Remove action from existing chassis/stock

**Step 1:** Loosen the two screws that hold the action into the stock. Next, pull the barreled action out of the stock. For Remington 700 – you will need to remove the box magazine parts.

## Part II: Install your action into the C-4 Chassis

**Step 1:** Before installing your action, remove the Barrel Shroud (NV Cap) from the chassis by removing its six screws using the 3mm hex bit provided then pulling the Barrel Shroud off the chassis.

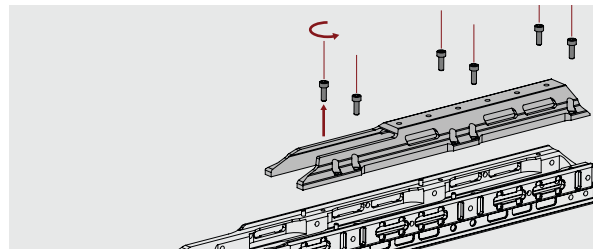

**Step 2:** On your first install, remove the adjustable Mag Spacer from the mag well to install front action screw more easily.

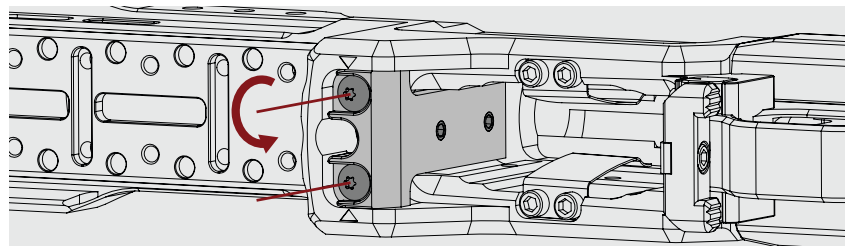

**Step 3:** Turn the chassis upside down and set chassis' bedding area (Radiused area for Remington) onto the action.

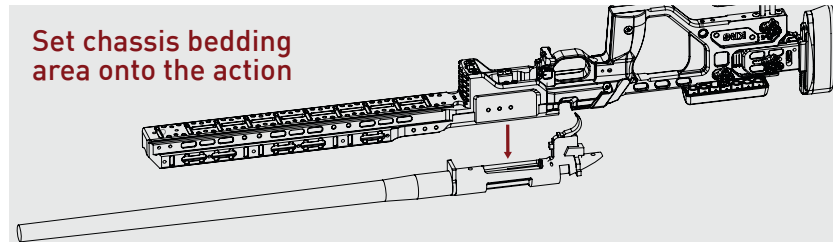

**Step 3:** Note: We highly recommend applying Blue Loctite to both action screws.

Drop the front action screw with Thin M6 washer into front mag well hole and the rear action screw with thin M6 washer into the hole just behind the trigger guard.

Using the 3/16" hex bit provided, turn the front and rear action screws clockwise to insert the threads into the action to draw the action into the chassis. Do not fully tighten at this point.

**Step 4:** Pull the action toward the rear of the chassis while holding the chassis stationary. This is to seat the recoil lug against the chassis.

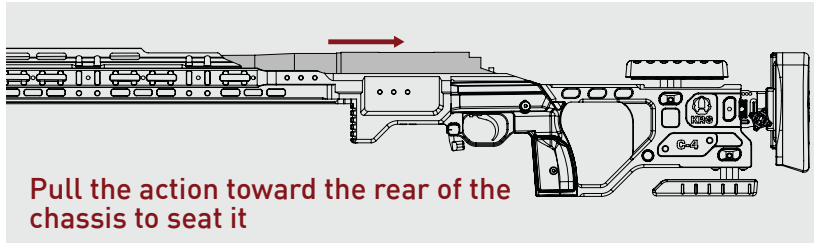
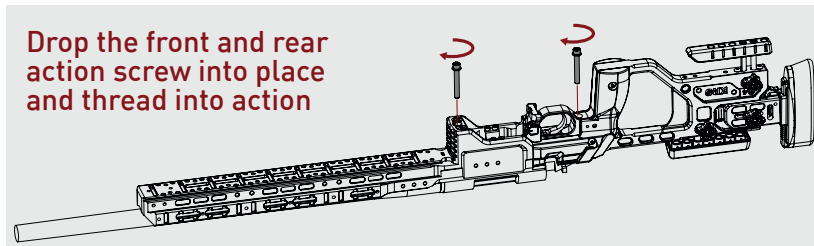

**Step 5:** Making sure the action is level and not canted to the left or right, next tighten both action screws until they are snug but not fully tightened.

**Step 6:** Torque both screws to 65 in-lbs in an incremental manner, moving back and forth between the two screws until full torque is reached.

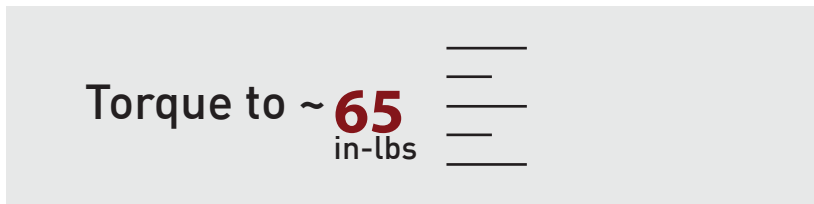

**Step 7:** Reinstall the Barrel Shroud (step 1 above) - recommended torque - 15 in-lbs and Mag Spacer (step 2 above) - recommended torque - 24 in-lbs

## Magazine Fit Adjustment

**Step 1:** Magazine height can be finely adjusted with the Mag Height Block screws on each sides of the Mag Release.

Tightening the screws (clockwise) will raise the magazine catch and thus the locking the magazine in at a higher point. AW-pattern magazines generally require a higher mag catch level than AICS-pattern magazines.

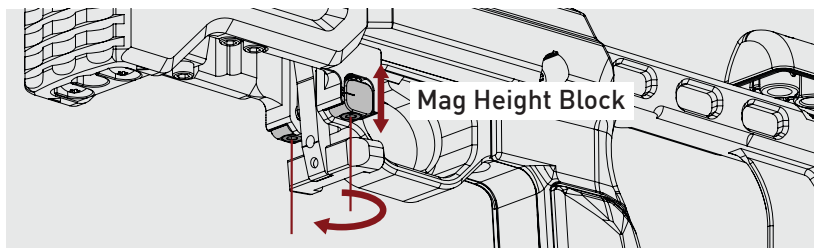

**Note 1:** Ensure that the Mag Height Blocks are raised/lowered equally to maintain optimum magazine contact.

**Note 2:** These screws are under spring tension and will come out completely if loosened too much.

**Step 2:** Magazine tension and forward spacing can be adjusted by releasing Mag Spacer with screws on the bottom and testing to reach your preferred magazine fit.

Recommended torque for Mag Spacer screws - 24 in-lbs

**Note:** The white center line on the Mag Spacer is only the default position which may or may not provide the magazine fit that you prefer. Fine tuning is recommended.

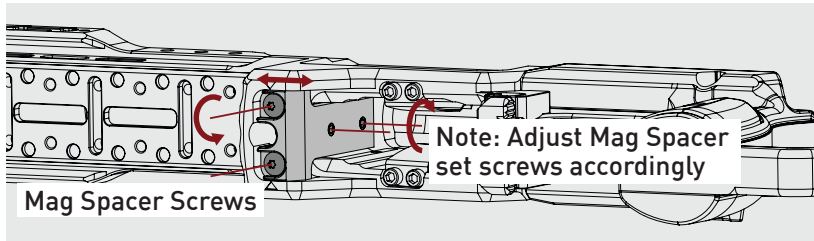

**Step 3:** Mag Tension Leaf Springs can be either completely removed or they can be bent to change their install angle then reinstalled to achieve desired lateral tension.

Recommended torque for Leaf Springs screws - 15 in-lbs

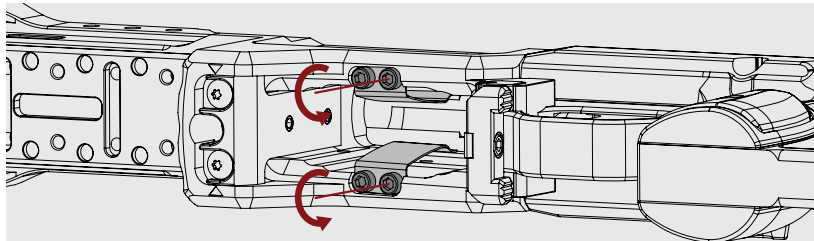

Time to adjust the chassis to fit you

## Length of Pull (LOP) Adjustment

**Step 1:** Loosen the LOP Thumbscrew until LOP Bar is released, adjust the length of pull in increments to desired position and retighten the LOP Thumbscrew.

**Note:** Do not remove LOP Thumbscrew completely, or LOP Lock and Springs will be disassembled.

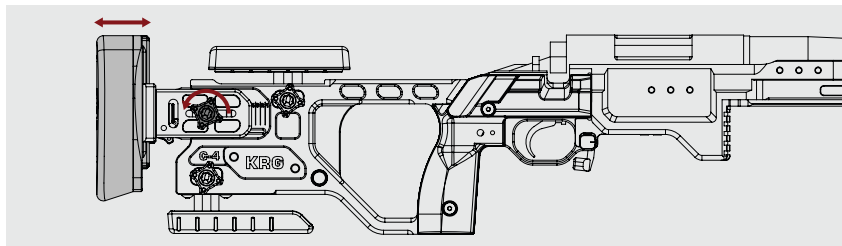

## Buttpad Height and Cant Adjustment

**Step 1:** Loosen the Buttpad Thumbscrew until the buttpad is loose, adjust to desired height and retighten.

The index markings should be used to remember your preferred setting.

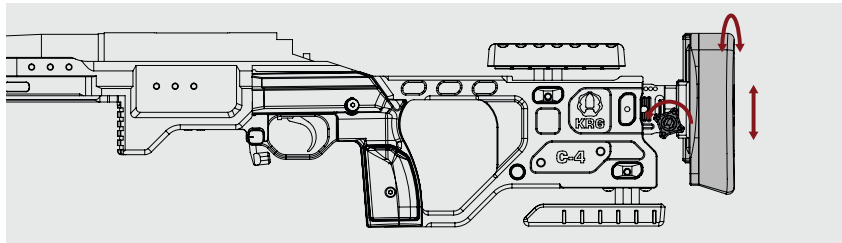

**Step 2:** To adjust the buttpad cant, first fully remove the Buttpad Thumbscrew.

Open the Clamping Arm holding the buttpad. The cant is set with a removable pin positioned between the LOP bar and Canting Clamp. Adjust and reassemble.

**Note:** Be mindful of the Spring between LOP Bar and Clamping Arm.

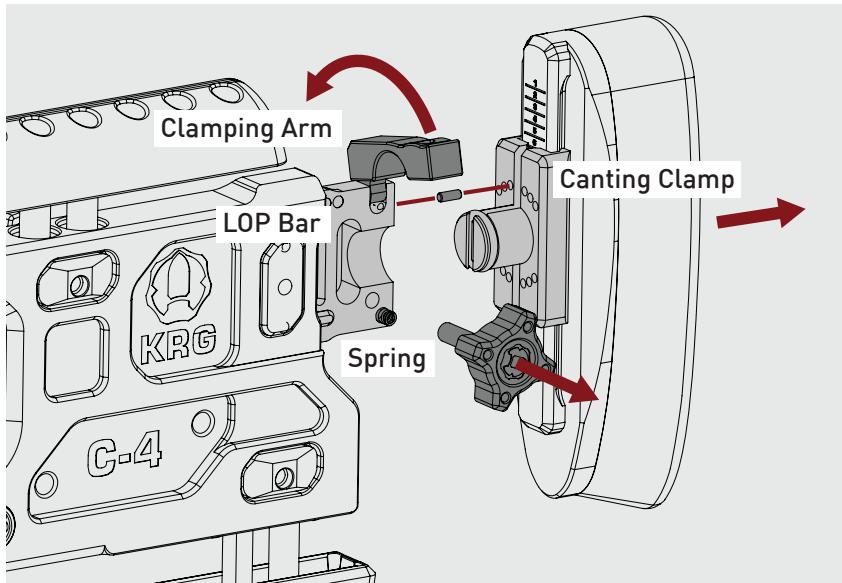

Canting Clamp set angles

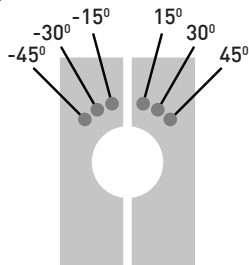

## Bag Rider Height Adjustment

**Step 1:** Loosen the bag rider thumbscrew until the bag rider is loose, adjust the height retighten.

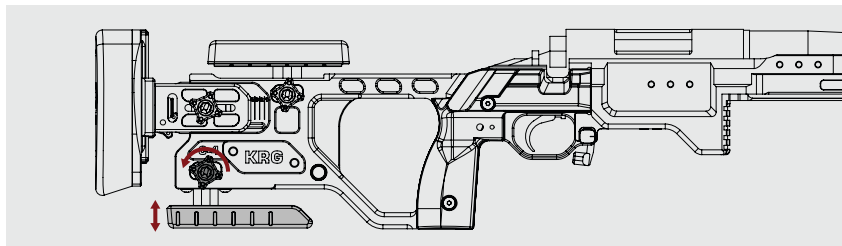

## Cheek Height Adjustment

**Step 1:** Loosen the thumbscrew and remove the cheekpiece.

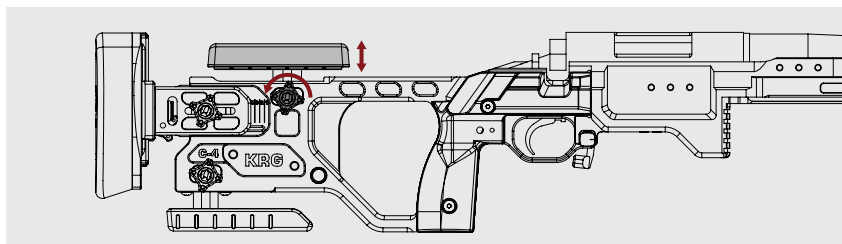

**Step 2:** Slide the o-rings toward the bottom of the riser posts and re-insert the cheekpiece.

**Step 3:** Getting into position behind the rifle, place your head gently on the cheekpiece. The cheekpiece should be too high for a proper view through the scope. With the thumbscrew slightly loose, push the cheekpiece down with your head until it rests in the proper position so you have a perfect view through the scope. Tighten the thumbscrew to lock the cheekpiece in that position. When you need to remove the rifle bolt from the action for cleaning, the o-rings will keep the position you selected when you re-install the cheek piece.

**Step 4:** Optional – You can move the cheekpiece fore and aft by removing the two screws holding the cheekpiece to the two cheek riser posts and then switching the holes in which the riser posts sit. (use 3mm hex wrench)

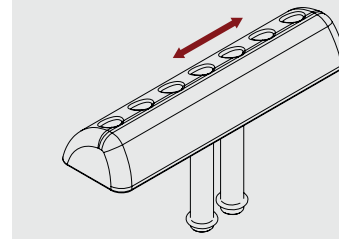
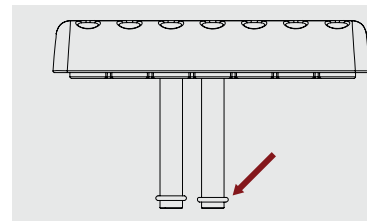

## Reversible Thumbscrew Controls

Cheekpiece and bag rider height adjustment thumbscrew

**Step 1:** Loosen the thumbscrew and remove the thumbscrew and two clamps.

**Step 2:** Reinstall on the opposite side.

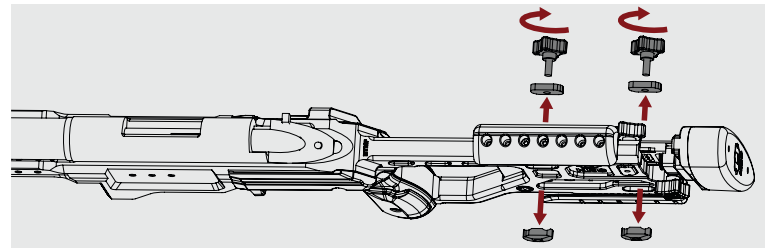

## Mounting Options Data

Bottom of Backend with Bag Rider removed

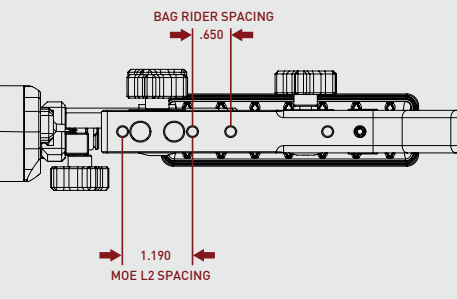

Bottom of Forend

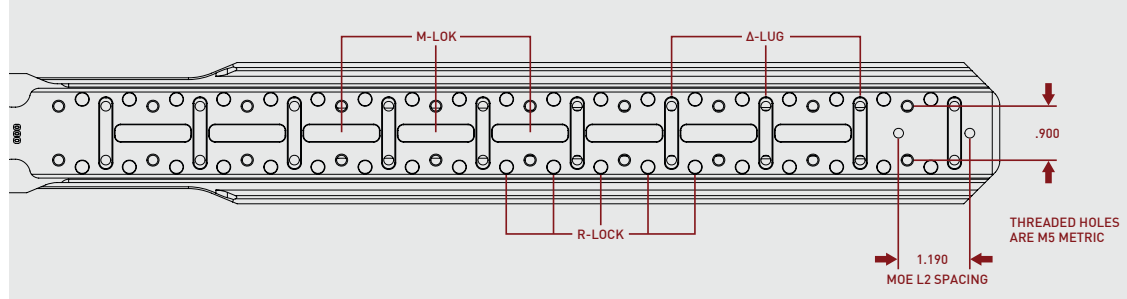

Side profile

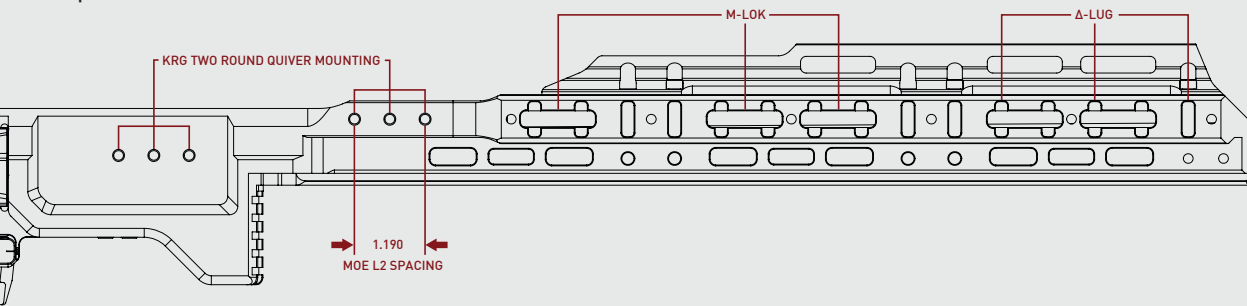

**Recommended torque specs:** - Barrel Shroud and Leaf Spring – M4 fasteners – 15 in-lbs  
- Mag Spacer – M5 fasteners – 24 in-lbs

**Tools required:** - 3mm hex wrench  
- 3/16" (Rem 700 Action Screw) hex wrench