

Thank you for purchasing the KRG Ruger American Bravo Chassis. We trust that you will enjoy your chassis and we think that you'll find it to be high quality and an exceptional value.



INST-BRV-RUG

# Ruger American Bravo Chassis

## Contents of Package:

- Ruger American:
  - 1ea 1/4-28 x 1 Socket Head Screw (Rear Action Screw with washer) - captured
  - 1ea 1/4-28 x 1/2 Socket Head Screw (Front Action Screw with washer) - captured
  - 1ea KRG L2 Rail Kit
  - 1ea 1-3 LOP Spacer Set
  - 1ea Forend Backer Nut Kit (for mounting accessories):
    - 4ea M5 Hex Nut
    - 4ea M5 Flat Weld Nut

## Installation Instructions:



**Safety Warning:** Before you attempt any installation, make sure your rifle is unloaded. Also, before starting remove the bolt and magazine from the rifle.

## Part I: Remove action from existing chassis/stock

**Step 1:** Loosen the two screws that hold the action into the stock. Next pull the barreled action out of the stock.

## Part II: Install your action into the Ruger American Bravo Chassis

**Step 1:** Remove green o-ring holding Rear Action Screw in position.

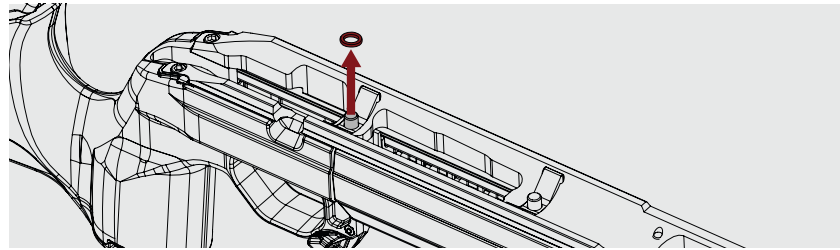

**Step 2:** Insert the barrelled action into the chassis, tighten the Front Action Screw and Rear Action Screw to finger tight.

Front Action Screw and Rear Action Screw are in place and captured by forend.

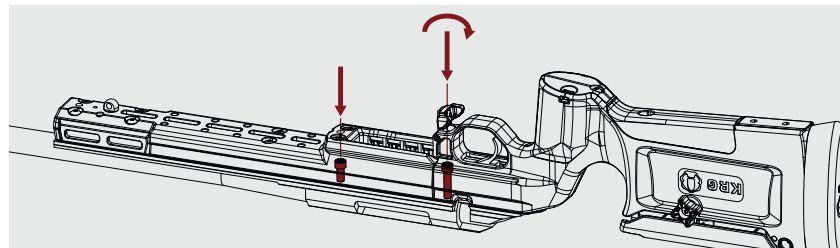
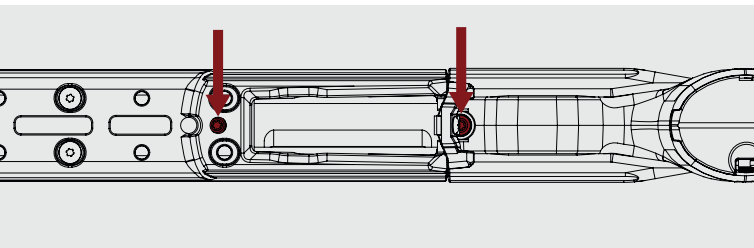

**Note:** If better access to the Rear Action Screw is needed, the magazine catch may be removed from trigger guard and reinstalled after action mounting is complete.

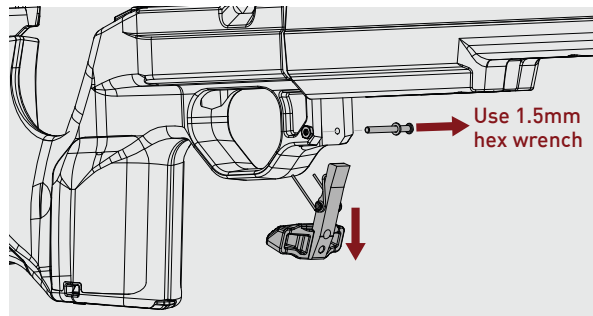

**Step 3:** Pull the action towards the rear of the stock while holding the stock stationary. This is to seat the action against the recoil lug. A good way is to set the rifle vertical on the buttpad and bounce it on the ground a couple times.

**Step 4:** Making sure the action is level and not canted to the left or right in the chassis, begin tightening the actions screws starting with the front screw, tightening a little and then moving to the back screw and tightening a little. Keep switching back and forth to ensure even tension until the screws are fully tightened.

**Step 5:** Torque both screws to **65 in-lbs of torque** in an incremental manner, moving back and forth between the two screws until full torque is reached.

**Step 6:** Insert a magazine to test for fit, the forend can be moved forward or backward a small amount to adjust the magazine fit. Due to the magazine design of the AICS magazine and the magwell of the Bravo Chassis, it may be possible to put pressure on the mag and push it up against the bolt. For this reason we do not recommend resting the gun on the magazine when firing.

Time to adjust the stock to fit you!

## Length of Pull (LOP) Adjustment

**Step 1:** Remove the buttpad using a 3mm metric hex/allen wrench.

**Step 2:** Push the installed M5 buttpad mount screws out of the buttpad. Replace these screws with the longer screws, which are long enough to go through your desired amount of spacers. Insert desired quantity of spacers onto the longer screws

**Step 3:** Install the buttpad back onto the buttpad stock with the spacers captured between them.

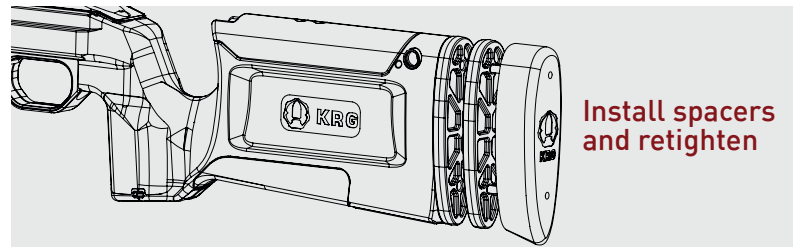
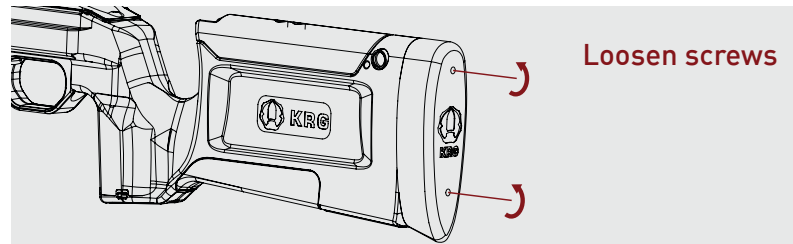

## Cheek Height Adjustment

**Step 1:** Loosen the thumbscrew and move the cheekpiece to your desired position. Retighten the thumbscrew.

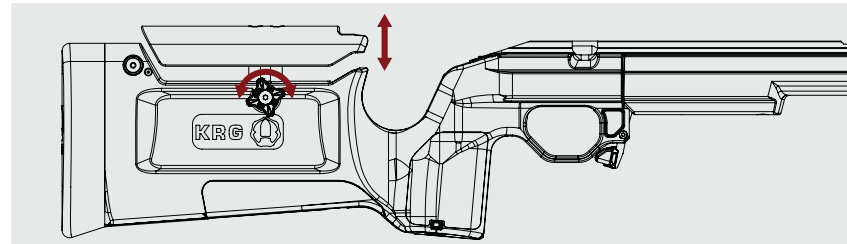

## Mounting Options Data

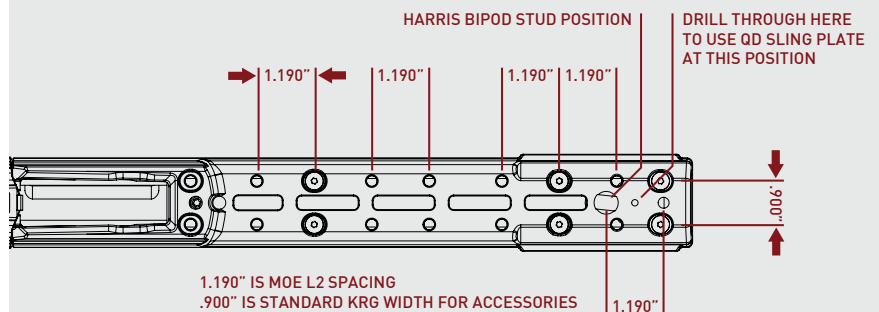
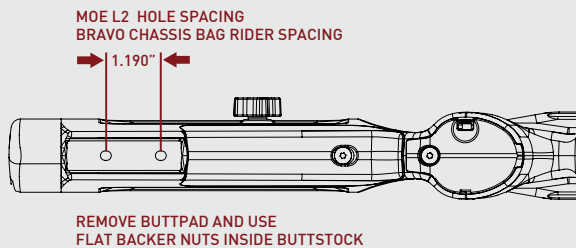

- |                                  |   |                        |   |
|----------------------------------|---|------------------------|---|
| <b>Recommended torque specs:</b> | <ul style="list-style-type: none"> <li>- Forend to Backbone – M5 fasteners – 24 in-lbs</li> <li>- ARCA Rail Mounting – M5 fasteners threading into Backbone – 24 in-lbs; M5 into Steel Hex Nut – 35 in-lbs</li> <li>- Spigot Mount – M4 fasteners – 15 in-lbs</li> <li>- NV Mount – M4 fasteners – 15-in-lbs</li> </ul> | <b>Tools required:</b> | <ul style="list-style-type: none"> <li>- 1.5mm, 3mm hex wrenches</li> </ul> |
|----------------------------------|---|------------------------|---|